

EN

fornello

Manual for installation
of
PELLET STOVE
Series REGINA, STELA
8 kW, 10 kW



НЕС - Нови Енергии

г. Шумен, бул. Мадара

12

тел: 054 874 536

факс: 054 874 556

e-mail:

[senw](http://www.senw.com)

v.01

senw@senw.com

Contents:

1	Safety Precautions	3
2	Technical characteristics	5
	2.1. Delivery and unpacking of pellet stove	5
	2.2. Description	5
	2.3. Technical parameters	6
3	Installation	7
	3.1. General rules	7
	3.2. Connecting of outer tube for fresh air flow	8
	3.3. Exhaust gas system	8
	3.4. Exhaust gas system requirements	9
	3.5. Type of tubes for exhaust gas system (chimney)	10
	3.6. Diagrams for installing the exhaust gas system /connecting the pellet stove to chimney/	10
	3.7. Roof installation of exhaust gas pipe	11
	3.8. Connection to the power supply	11
4	Fuel	12
5	Exploitation of pellet stove	14
	5.1. Safety precautions	14
	5.2. Before first start of pellet stove	14
	5.3. First start of pellet stove	14
6	Controller	15
	6.1. Description	15
	6.2. Wiring	16
	6.3. Control panel. Functions	18
	6.4. User Menu (1)	20
	6.5. User Menu (2)	23
	6.6. Functioning States	25
	6.7. Functions	30
7	Cleaning and maintenance	34
8	Aftersales service	37
9	Warranty terms	37
10	Recycling and waste disposal	37

НЕС - Нови Енергийни Системи ООД гр. Шумен, бул. Мадара 12

тел: 054 874 536 факс: 054 874 556 e-mail: service@sunsystem.bg
www.sunsystem.bg

*	It is mandatory to assure a backup power generator of corresponding rated power!
*	WARNING! Installation and setup of the stove should be done by an authorized specialist / service shop and must follow the safety instructions and rules of operation.
*	Customer must undergo boiler operation/maintenance training by authorized installer / service shop.

1. Safety Precautions

Pellet stove FORNELO 8 kW and 10 kW is designed in order to give maximum security

and ease of use. Still you should follow the following safety precautions:

1. We recommend to the authorized installer not to leave bare wires not entirely fit into the terminals. To prevent the contact of bare wires with other parts.
2. The installation process must be performed only by an authorized by the manufacturer installer. Once the installation is finished the authorized installer is obliged to give to the end user dully filled warranty card and service card, certifying that the pellet stove is installed according to all the standards applicable and the installer takes full responsibility for the installation.
3. It is important to obey all the applicable standards in the country where the product is to be installed.
4. The manufacturer bares no responsibility if the above pointed duties are not kept.
5. The instruction manual for use and installation is an integral part of the product. In case it is missing or lost the end user must notify the installer and/or the manufacturer in order to receive a new copy.
6. This pellet stove should be used only for the purpose for which it was intended.
7. The manufacturer bares no responsibility for damages suffered by people, animals or objects because of wrong installation or misuse.
8. After removing the packaging material the end user must check up if all the parts/units are available and if something is missing he should notify the seller in order to receive the missing part.
9. Only original parts must be used for servicing. Contact an authorized service for

the products FORNELO.

10. Obligatory maintenance - the pellet stove must be cleaned immediately after each consumption of certified pellets between 800 kg to 1000 kg or if usage is less at least once a year. This maintenance must be performed by an authorized by FORNELO service center. As long as the pellet stove is in its warranty period all the maintenance and service must be performed by the authorized service who has performed the initial installation.

For safety precautions the following rules must be strictly followed:

- The pellet stove must not be operated by children or people with disabilities.
- It is forbidden to install the pellet stove in wet or moist spaces such as bathroom, laundry etc. It is forbidden to touch the pellet stove with wet hands or feet.
 - It is forbidden to change or not to follow the safety precautions without permission by the authorized service / installer FORNELO.
 - The power cable must be protected from damage or disconnection.
 - Children or people with disabilities are forbidden to access unattended the room where the pellet stove is installed.
 - The door of the pellet stove must be closed when the product is in working mode.
 - Avoid direct contact with the hot surfaces of the pellet stove.
 - Check for difficulties when starting the pellet stove before the start of the heating season or in cases when the product has not been used for a long time.
 - The pellet stove is designed to work even in extreme weather. Still in case of strong wind or very chill weather the safety system of the product may automatically turn of the pellet stove. In that case the end user must notify authorized service /installer FORNELO. It is not recommended to deactivate or restart the safety functions of the product at your own.
 - Stove installation room must be equipped with fire extinguisher in case of fire in the exhaust gases tube.

2. Technical characteristics

2.1. Delivery and unpacking the pellet stove

The pellet stove is delivered on wooden pallet, packed in carton box wrapped in foil and additionally secured with packing strap.

Unpack carefully. Check the product for visible defects or damages. Check the door glass. Open the container for pellets and check the availability of the following additional units:

- Remote control
- Controller + mounting screws set M5
- Instruction manual
- Power supply cable

Check the availability of Technical (instruction manual, service and warranty card). Read carefully the documentation and do not throw away.

In case of visual defect, damage or missing part notify immediately your seller.

2.2. Description of pellet stove

Pellet stove **FORNELO - 8W, 10kW**

is designed to be connected to a heating installation and is suitable for use in houses, offices, small restaurants etc.

The product contributes for the comfort and the nice atmosphere in the room.

The burner is iron by special technology from fire durable alloy. The door of the pellet stove is sealed hermetically when closed.

The ceramic glass of the door is heat resistant – up to 700°C– and thanks to it you could safely watch the fire (the



glass prevents the contact with smoke or dangerous sparks of fire)

Elements of the pellet stove:

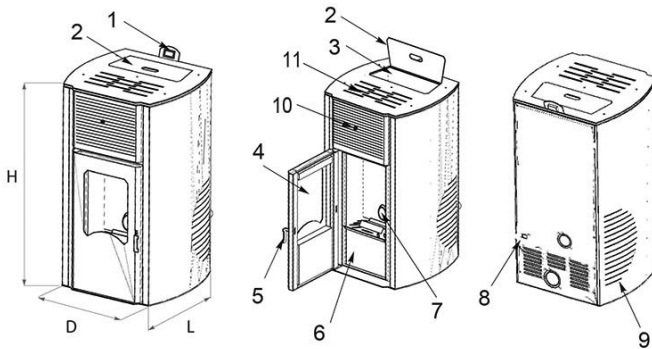

1 - Controller	6 - Ash container
2 - Cover of pellet container	7 - Pellet Burner
3 - Pellet container	8 - Power supply
4 - Ceramic glass	9 - Decorative side panels
5 - Door lock	10 - Lever for pipe cleaning
	11 - A bowl for water for air humidifier

2.3. Technical parameters:

Model PD Comfort Plus		8 kW	10 kW
Height	mm	970	1020

	Width	mm	430	510
	Depth	mm	580	610
	Weight	kg	80	100
	Flue (exhaust gas tube), diameter	mm	∅ 75	∅75
	Exhaust gas temperature	°C	<180	<180
	Incoming-air tube, diameter	mm	∅ 32	∅32
	Container for pellets - capacity – max. quantity	kg	8	15
	Nominal power	kW	8	10
	Heat power /reduced power/	kW	5	8
	Average fuel consumption per hour	h/kg	0,7	1,1
	Burn time of full pellet hopper at max.power	h	12	14
	CO content calculated to 13% O ₂ in the flue gas at nominal heat output		0,03%	0,03%
	Efficiency	%	90	92
	Electrical power	W	120	120
	Supply voltage	V/Hz	230/50	230/50
	Recommended fuel		Wood-pellets 6-8 mm, EN 14961-2:2011	

The values in the table above are presented on a test base, performed by burning wooden pellets with calorific values 18220 Kj/kg (equal to 4350 Kcal/kg).

All the data above is informative and not obligatory.

The manufacturer reserves his rights to change the data at any time aiming to improve the efficiency of the pellet stove.

3. Installation

3.1. General rules

Correct mounting and connection of exhaust gas system is extremely important for safety use of pellet stove.

Any mistakes done during the installation are not covered by the MANUFACTURER.

It is obligatory the installation, the first start and the maintenance of the pellet stove to be performed by an authorized installer / service FORNELO!

Recommendations BEFORE installing the pellet stove:

- Check the minimum volume of the room where the pellet stove is to be installed (should be no less than 40 m³);

- Make sure there are holes for fresh air;
- Follow all the norms/standards – technical, safety and constructional;
- The proper functionality of the exhaust gases system (chimney reliability);
- It is not permitted the installation of the pellet stove to be performed in bedrooms, bathrooms as well as rooms which already had another heating unit installed without enough access of fresh air (another stove, gas heater etc.);
- An air extraction device shall not be used in the same room as the appliance unless adequate additional ventilation is provided;
- There should not be any flammable substances in the room where the installation will be done;
- The space around the pellet stove should be built with stones, cement or any other fireproof material;
- The minimum distance from flammable materials must be 200 mm. In case the floor is made of flammable material (wood / parquet floor) it must be insulated with nonflammable one;
- The steel pipes for exhaust gases must be mounted at distance minimum 1.5 m. From any flammable materials. We recommend the pellet stove to be installed as closer as possible to the exhaust system (chimney). The pipe system for the exhaust gases must be with maximum 3+1 T knees and maximum 3 m. from the horizontal flow with minimum deviation 3-5%.

After the place for installation is defined unpack the unit and check the closing of the front door.

3.2. Connecting of outer tube for fresh air flow

For proper functioning and distribution of the temperature the pellet stove must receive enough fresh air flow and to be well positioned (a special opening for fresh air could be done for example).

The opening for the fresh air must be minimum 100 cm² and there should not be any obstacles on its way. If an air extraction device is installed within the same room as the pellet stove it is mandatory that adequate fresh air supply is provided for sufficient ventilation. Fresh air could be taken also from other room which has its own constant ventilation and no other pellet stove or similar heating system, which needs also fresh air flow. This room cannot be bedroom, bathroom or any other room that are fire hazard for instance garages, basements, stores etc.

If the pellet stove in the room uses gas from an open system or another source of harmful gases the air flow must come directly outside the room from the environment.

Example: Connection of tube for fresh air flow directly from the outside

For proper functioning of the pellet stove it is recommended to make a direct connection from outside the room with steel pipe 80 mm with silicon gasket. The part of the tube that goes outside the room must be situated downwards 90° - in this way a protection against wind, water, etc. is achieved.

Keep the following distances:

- 1,5 m floor,
- 1,5 m horizontal,
- 0,3 m from doors, windows
- 2,0 m exhaust gases system.

The manufacturer bares no responsibility for damages caused by not keeping the instructions.

3.3. Exhaust gas system

The correct installed system for exhaust gases is of extreme importance.

It is obligatory the installation to be performed by an authorized installer / service FORNELO !

Recommended parameters for installing the exhaust gas system:

Model		8 kW	10 kW
Draught chimney	Pa	10	10
Exhaust gases flow	g/s	30,2	32,5
CO measured for 13% oxygen	%	0,016	0,014
Temperature of exhaust gases	C°	180	180

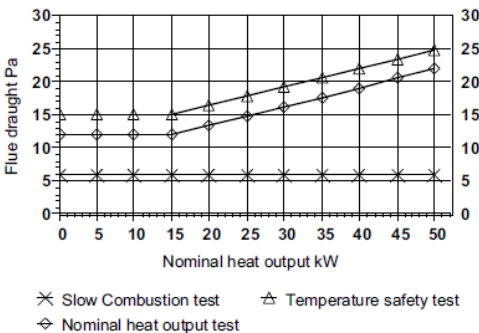

Figure 1 - Flue draught values

Table 5 - Carbon monoxide emission classes

Appliance CO Class	CO emission class limits (at 13 % O ₂) %
Class 1	≤ 0,3
Class 2	> 0,3 ≤ 0,8
Class 3	> 0,8 ≤ 1,0

3.4. Exhaust gas system requirements:

Exhaust gas system meet the following requirements:

- made of suitable materials
- hermetically sealed - silicone gaskets on chimney tubes
- to be suitable for wok mode under high pressure and temperature 200°C -250°C (recommended thickness of the pipes no less than 1mm).
- In case you want to connect the pellet stove to the already existing exhaust gas system (chimney), its condition must be validated by an authorized installer.
- It is recommended the exhaust gas system (chimney) to be cleaned periodically.

3.5. Type of tubes for exhaust gas system (chimney)

The tubes must be solid, smooth inside, mad of steel and must be accompanied by silicone gaskets.

The diameter of tubes long up to 3 m, must be 80 mm.

The diameter of tubes long more than 3 m must be minimum 100 mm as it is necessary to obtain the required draught of the chimney (see 3.3).

The length is calculated as the requirements in 3.1 are kept.

ATTENTION! Do not connect the exhaust gas system to a chimney in which already is connected another stove, boiler or ventilation system!

3.6. Diagrams for installing the exhaust gas system /connecting the pellet stove to chimney/ Diagrams are an example only.

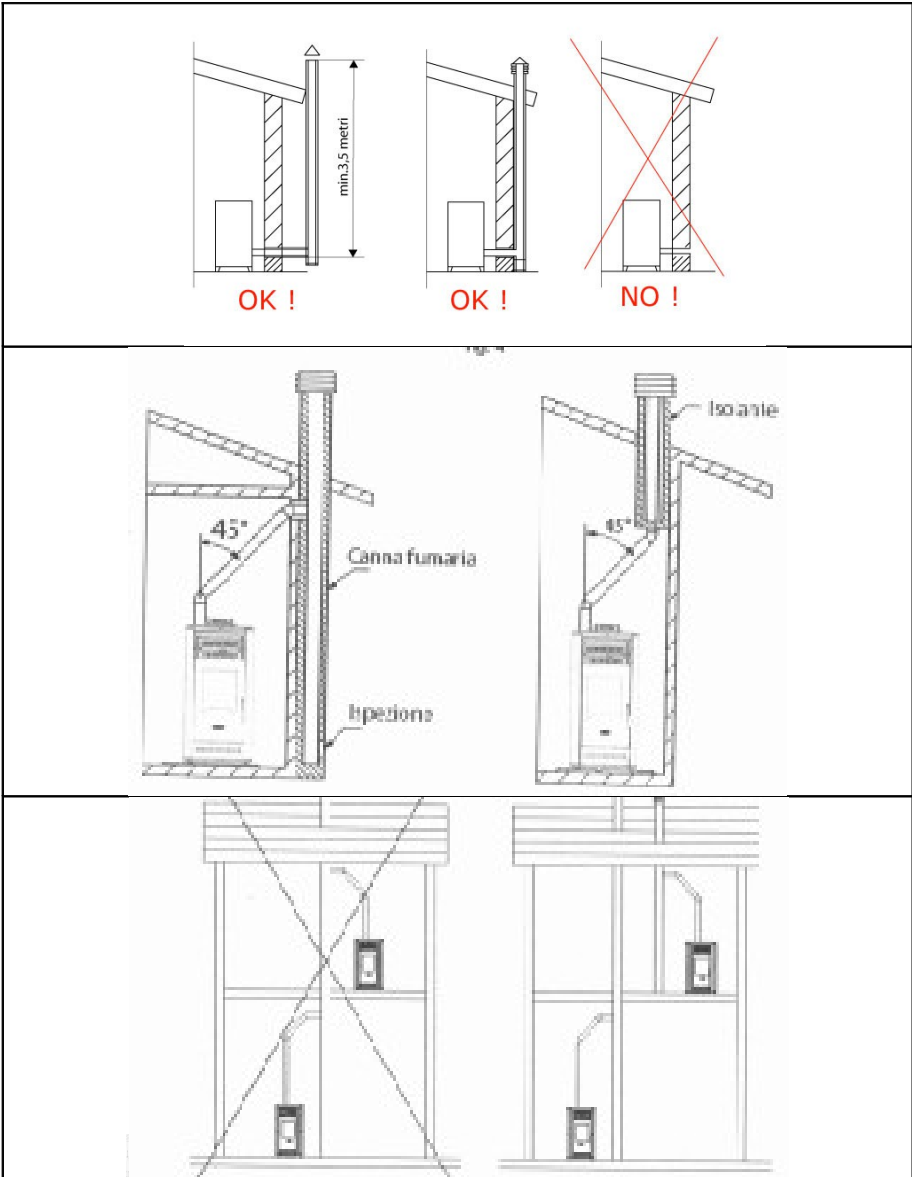

3.7. Roof installation of exhaust gas pipe

The upper part of the pipe (chimney) is designed for the proper outlet of the exhaust gases in the atmosphere. The tube must be protected from rain, snow and all

objects,
and to ensure discharging of exhaust gases in the atmosphere under windy conditions.

Requirements for the upper part of the tube:

- The inner part must not be less than the one on the pellet stove;
- The outer part of the pipe to be insulated;
- The authorized installer must protect the system from rain, snow and winter;
- Easy dismantling for cleaning;
- The type of the tube must be such that fits in the aesthetic appearance of the building;
- Not to be close to obstacles and other chimneys.

The distance between the tube and other obstacles (walls, trees and others) must not to be less than 10 m.

If the distance is less than 10m the height of the tubes must be 1m above the obstacles (walls, trees, etc.).

If there are other chimneys – the exhaust gases pipe must be at distance no less than 2m from it.

We recommend the exhaust gases pipe to be at least 1m above the roof.

Problems with exhaust gases:

Among all the atmosphere influences on the system the wind matters most.

3.8. Connection to the power supply

Once the pellet stove is installed in the room it must be connected to the power supply. The power cable is situated at the back part of the pellet stove.

Check the condition of the cable. If any damages are noticed notify an authorized service for exchange.

Before connecting the pellet stove to the power supply check carefully:

- Whether the characteristics of the electrical supply match the requirements indicated on the label of the pellet stove.
- Weather the connection is correctly grounded.
- The cable must not be with temperature higher than 75°C.
- In case of direct connection to the power supply – contact an authorized electrician to perform the action.
- Turn off the pellet stove from the power supply when the product is not intended to be used for a long period of time.
- The connection with the power supply must be easy to access in order to be able to

easily disconnect the plug in case of accidents.

4. Fuel

ATTENTION! Pellet stove is tested only with wood-pellets with diameter 6-8mm, class EN plus A1, according EN 14961:2011.

Use only the fuel indicated in this manual! Otherwise the warranty will be void.

All pellets are biomass manufactured from common low-growing plants and trees. The most common household type pellets are made of sawdust and milled wood chippings which are waste material from wood used in the production of logs, furniture and other products. Wood is the richest raw material which does not have any impact on the production costs of food products or ethyl alcohol (ethanol). The raw material is processed under high pressure and temperature and is pressed to produce small-size cylindrical pellets. The production process may utilize soft wood material (such as softwood, pine), hardwood (oak) as well as recycled waste wood. Wood pellets are produced in hammer mills or wood pellet plants.

Advantages of wood pellets: Convenient storage. Pellet bags can be stored on a small area in a dry garage, basement, service room or shed. Easy loading. Better control of fuel quantity. The small size of the pellets allows for precise fuel feeding. On the other hand, the supply of air for reaching optimal combustion efficiency is easier to adjust since the fuel quantity in the combustion chamber remains constant and predictable. Fuel efficiency. High combustion efficiency is also determined by consistently low moisture content of pellets (consistently under 10% as opposed to 20% to 60% moisture content of the logs). Low moisture content, controlled fuel portions and precise air setting means high combustion efficiency and very low carbon oxides in the flue gases.

Table: European Certification of Wood Pellets for Heating Purposes

Parameters	Measures	ENplus-A1	ENplus-A2	EN-B
Diameter	mm	6 (± 1)	6 (± 1)	6 (± 1)
		8 (± 1)	8 (± 1)	8 (± 1)
Length	mm	15 ≤ L ≤ 40 1)	15 ≤ L ≤ 40 1)	15 ≤ L ≤ 40 1)
Bulk density	kg / m ²	≥ 600	≥ 600	≥ 600
Calorific value	MJ / kg	≥ 16,5-19	≥ 16,3-19	≥ 16,0-19
Humidity	Ma .-%	≤ 10	≤ 10	≤ 10
Dust	Ma .-%	≤ 1 3)	≤ 1 3)	≤ 1 3)

Mechanical strength	Ma .-%	≥ 97,5 4)	≥ 97,5 4)	≥ 96,5 4)
Ash	Ma .-% 2)	≤ 0,7	≤ 1,5	≤ 3,5
Ash melting point	°C	≥ 1200	≥ 1100	-
Content of chlorine	Ma .-% 2)	≤ 0,02	≤ 0,02	≤ 0,03
Content of sulfur	Ma .-% 2)	≤ 0,03	≤ 0,03	≤ 0,04
Content of nitrogen	Ma .-% 2)	≤ 0,3	≤ 0,3	≤ 1,0
Content of copper	mg / kg 2)	≤ 10	≤ 10	≤ 10
Content of chromium	mg / kg 2)	≤ 10	≤ 10	≤ 10
Content of arsenic	mg / kg 2)	≤ 1,0	≤ 1,0	≤ 1,0
Content of cadmium	mg / kg 2)	≤ 0,5	≤ 0,5	≤ 0,5
Content of mercury	mg / kg 2)	≤ 0,1	≤ 0,1	≤ 0,1
Content of lead	mg / kg 2)	≤ 10	≤ 10	≤ 10
Content of nickel	mg / kg 2)	≤ 10	≤ 10	≤ 10
Content of zinc	mg / kg 2)	≤ 100	≤ 100	≤ 100

1) Not more than 1% of the pallets must be longer than 40 mm, maximum length 45 mm;

2) Dry volume;

3) Particles <3.15 mm, fine dust particles, before delivery of the goods;

4) For measurements with lignotester the maximum allowed value ≥ 97,7 weight %.



When purchasing pellets, ask for conformity declaration and certificate issued by an accredited laboratory and make sure the fuel meets the requirements indicated in the manual. If you purchase large amount of pellets (bulk supply for the entire heating season for example), ask your supplier to provide accurate and true information about the storage conditions.

We recommend to use pellet with size of 6 - 8 mm, Density 600-750 kg/m³ heating value 4,7 -5,5 kWh/kg. Ash content – less than 1% and moisture content up to 8%., EN 14961-2:2011.

The optimal density of the pellets which guarantees their quality is 605-700 kg per cubic meter.

Pellet moisture content must not exceed 10%. Make sure you store your fuel in a dry and well-ventilated place.

The optimal pellet ash content is ≤ 1%. This also provides for less frequent cleaning intervals for the burner.

5. Exploitation of pellet stove



ATTENTION! MUST BE PERFORMED ONLY BY AN AUTHORIZED INSTALLER / SERVICE!

5.1. Safety precautions

Pellet stove develops high temperature during operation mode. Beware of hot surfaces - danger of burns. Do not leave the children and disabled people unattended close to the product.

- It is forbidden the children and disabled people to operate the pellet stove.
- It is forbidden to pour water or other liquids which can cause temperature shock.
- Risk of fire. Keep the flammable (paper, plastic, etc.) materials and liquids (spirits, etc.) at distance from the hot surface of the pellet.

5.2. Before first start of pellet stove

When stove installation is done may start the first ignition and may be set all parameters.

To set parameters use controller display or use PC with correct software.

5.3. FIRST START OF PELLETS STOVE:

- Make sure that all the wires are connected properly
- Switch on the pellet stove
- Perform the set up.

6. Controller /Code PSYSQ 0100012/

6.1. Description

EasyTech.One is a Pellet stoves control system available in Air and Hydro version. Is characterised by:

- Installing and use simplicity
- Reliable and flexible functioning software
- Simple and direct user's functions
- Advanced functions available for the authorized installer to adapt to different stoves and installations.

Product composition:

- Control Board with 4 fixing points, solid and sure.

- Extractable connectors.
- Exhaust gas temperature probe up to 500 °C.
- Room Temperature Probe.
- Stove (boiler) Probe.
- Connection cable Main Board - Control Panel.
- Control Panel with antistatic cover.
- Connector RS232 for the Modem/ Computer connection.

Before working on the system make follow:

- The accident prevention and Room prevention rules.
- The National Institute rules against the work accidents.
- The legal safety rules.

Conformity declaration:

Applied rules: EN 60730-1 50081-1 EN 60730-1 A1 50081-2

6.2. Wiring

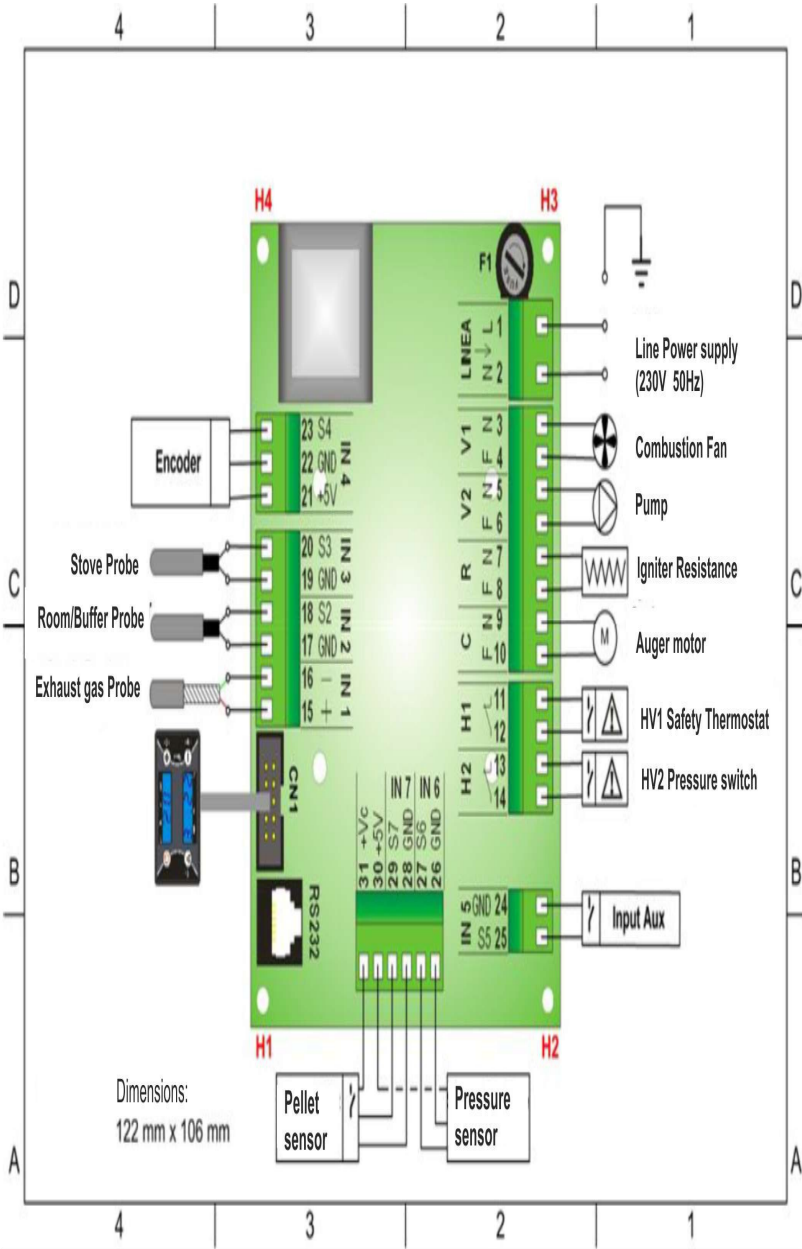

PIN		FUNCTION	CHARACTERISTICS
1	N	Voltage Power Supply	230 Vac \pm 10% 50/60 Hz F1= Fuse T5,0 A
2	L		
3	N	Combustion Fan	Triac Regulation 1A max
4	L		
5	N	Heat exchanger fan	Triac Regulation 1A max
6	L		
7	N	Igniter Resistance	Relè 3 A max
8	L		
9	N	Auger Pellet Engine	Triac Regulation 1A max
10	L		
11		Safety Thermostat Input HV1	Contact ON/OFF Normally closed To Bypass if not used
12			
13		Safety Pressure Switch Input HV2	Contact ON/OFF Normally closed To Bypass if not used
14			
15	Red +	Exhausting Temperature Probe	Thermocouple K: 500 °C Max
16	Green -		
17		Probe or Room Thermostat / Buffer Probe	NTC 10K @25 °C: 80 °C Max
18			
21	+5V	Encoder Signal	Signal TTL 0 / 5 V
22	GND		
23	SEG		
24		AUX Input: Chrono/Room Thermostat	Contact ON/OFF
25			
28	GND	Sensor Pellet level	Signal 0 / 5 V
29	SEG		
31	+V		
CN1		Connector to Keyboard	Flat Cable
RS23		Connector RS232	Connection to Modem/Computer

6.3. Control panel. Functions

-1- LED / Display		
LED	Fix	Blinking
L1	Stabilization phase	Ignition Start phase
L3	Stove OFF	Extinguishing phase
L4	Work phase	Modulation/Standby phase
L5	Engine Auger ON	
L6	Igniter Resistance ON	
L7	Chrono Program enabled	
L8	Heat exchanger fan ON	
D1	Time	
D2	Work Combustion Power set	Combustion power change
D3	Set maximum room temperature	Change in maximum room temperature



-2- Buttons		
Key	Click [P click]	Long Pressure [P long]
P1	Display other data / Shows moment values/	Ignition / Extinguishing / Block Reset
P2	Combustion Power Setting	Manual Pellet Loading
P3	Setting of room temperature (+)	Pellet Loading Correction
P4	Setting of room temperature (-)	Combustion Fan Speed Correction

-3- Alarms		
DESCRIPTION		Error Code
Safety Thermostat HV1: signalled also in case of Stove OFF	Block <i>ALt</i>	<i>Er01</i>
Safety Pressure Switch HV2: signalled with Combustion Fan ON	Block <i>ALt</i>	<i>Er02</i>
Extinguishing for Exhausting Temperature lowering	Block <i>ALt</i>	<i>Er03</i>
Extinguishing for Exhausting over Temperature	Block <i>ALt</i>	<i>Er05</i>
Encoder Error: No Encoder Signal (in case of P25=1 or 2)	Block <i>ALt</i>	<i>Er07</i>
Encoder Error: Combustion Fan regulation failed (in case of P25=1 or 2)	Block <i>ALt</i>	<i>Er08</i>
Failed Ignition	Block <i>ALt</i>	<i>Er12</i>
Lack of Voltage Supply	Block <i>ALt</i>	<i>Er15</i>
Lack of fuel	Block <i>ALt</i>	<i>Er18</i>
DAY and TIME not correct due to prolonged absence of Power Supply	Block <i>ALt</i>	<i>Er11</i>
Anomaly in probe control during Check Up phase		<i>Sond</i>
Low pressure in the Stove	Block <i>ALt</i>	<i>Er09</i>
High pressure in the Stove	Block <i>ALt</i>	<i>Er10</i>
The reset of the BLOCK Condition is done by the Long Pressure of the button P1		

6.4. User Menu (1)

6.4.1. Ignition / Extinguishing

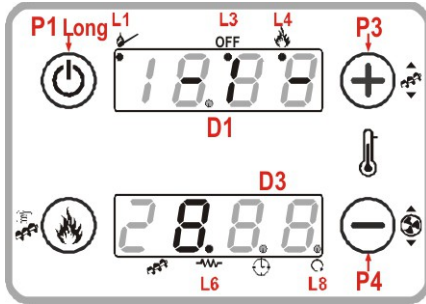

The Ignition and the Extinguishing are activated with a long pushing of the button **P1**.

The Ignition is signaled by the first blinking than fix led **L1**.

The Work state is signaled by the fix led **L4**. The Modulation state is signaled by the blinking **L4**.

The Extinguishing is signaled by the blinking led **L3**.

The Extinguishing finished =OFF state is signaled by the fix led **L3**.

6.4.2. Combustion Power Setting

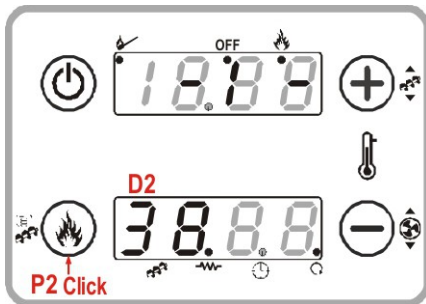

Click button **P2**: the display **D2** blinks. With other click of the button **P2** the power is changed according to the values.

Example: 1 – 2 – 3 – 4 – 5 – A
(A= Automatic Combustion)

After 3 seconds the new value is memorised and the display shows as normal.

6.4.3. Work Thermostat Setting

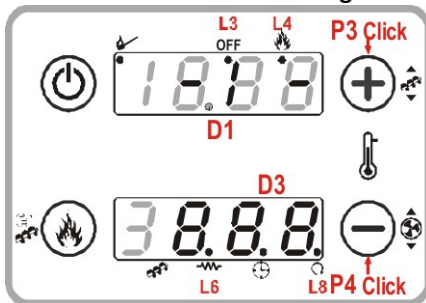

Click button **P3** or **P4**: the display **D3** blinks. With other click of the buttons **P3 / P4** the value of the thermostat is increased or decreased.

After 3 seconds the new value is memorised and switches to the current value of room temperature.

6.4.4. Manual Pellet Loading

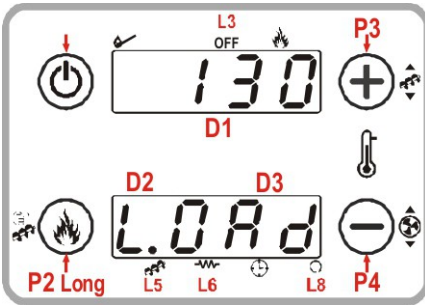

The long pressure of button **P2** activates the Pellet Manual Loading with activation of Auger engine in continuous way. The bottom display shows the actual function. The top display shows the passed loading time.

To stop the loading push any button.

The loading stops automatically after 300 seconds.

6.4.5. Pellet Loading Correction

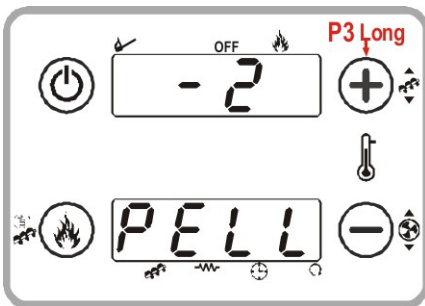

normal.

The activation is with a long pushing of the button **P3**.

The bottom display shows **PELL**.

The Display **D1** shows the blinking value.

With buttons **P3 / P4** the blinking value increases or decreases.

The values are between the range $-7 \div 7$.

The default value is '0'.

After 3 seconds the new value is memorised and the display shows as

6.4.6. Combustion Fan Speed Correction

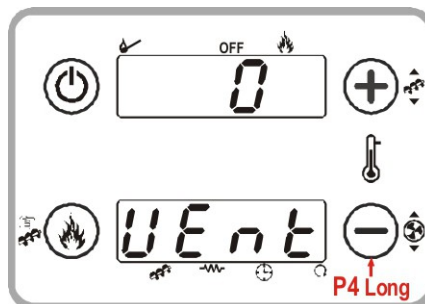

The activation is with a long pushing of the button **P2**.

The bottom display shows **UEnt**.

The Display **D1** shows the blinking value.

With buttons **P3 / P4** the blinking value increases or decreases. The values are between the range $-7 \div 7$.

The default value is '0'. After 3 seconds the new value is memorised and the display shows as normal.

6.4.7. Display

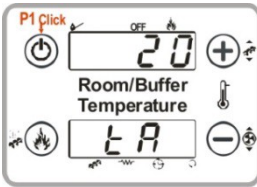

The activation is with a click of **P1**.

tA = Room Temperature



tF = Exhaust gas Temperature

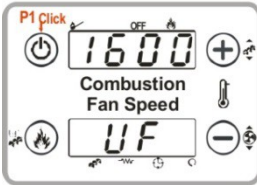

UF = Combustion Fan Speed [RPM/Volt]



HF02+Product Code

6.4.8. Radio Remote Control

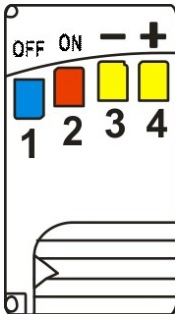

Button 1 (blue) activates Extinguishing.

Button 2 (red) activates Ignition.

Buttons 3 (yellow) / 4 (yellow) decrease / increase the Power Combustion.

Code Change:

On the Remote Control:

- Open the battery box moving right the cover.
- Modify dip-switch's configuration and close the box.

On the Thermoregulator:

- Switch OFF the power supply (230 V AC).



- Switch ON the Power Supply pressing at the same time one button on the Remote Control waiting about 5 seconds until an acoustic signal is emitted confirming the code learned.



6.5. User Menu (2)

Push contemporary buttons **P2** and **P4** for 3 (three) seconds to enter User Menu (2).

- To scroll the Menu push buttons **P3** or **P4**.
- To enter in a submenu push button **P2**.
- To modify the blinking value push button P3 (to increase) or P4 (to decrease).

- To exit push button **P1**.

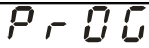
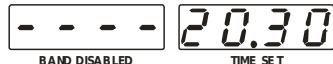
6.5.1. Thermostats	tErn
Room Thermostat /Function Buffer Thermostat It allows to set the Room Thermostat value P26=0 and A19 =1 Or Function Buffer Thermostat P26=1	 

6.5.2. Chrono	CrOn
Allows to program the ignitions/extinguishing of the system -1- Enable It enables the Programming set. Push button P2 to enter. Push buttons P3/P4 for select. ON= enable programming set OFF= disable programming set. Push button P2 to confirm, or push P1 to exit.	
-2- Program It allows to schedule the 3 time bands available for every day of the week. Select PrOo . Push button P2 to enter. Use buttons P3/P4 to visualize the time bands set: <u>Upper display visualizes:</u> the TIME SET - - - - if the BAND is disabled.	  

<p><u>Bottom display visualizes:</u> DAY / BAND / ON/OFF The long pressure of button P1 Enables / Disables the selected time band.</p>	
<p>PROGRAMMING AROUND MIDNIGHT - Set Hour of On for previous day to desired value: Example 20.30 - Set Hour of OFF for previous day at: 23:59 - Set Hour of On for the next day at 00:00 - Set Hour of OFF for the next day to desired value: Example 6:30</p> <p>The system will turn On Tuesday, at 20.30, and will turn Off on Wednesday, at 6.30</p>	

<p>6.5.3. Time and Day of the week</p>	
<p>It allows to set the current time and day of the week.</p>	

<p>6.5.4. Radio Remote Control</p>	
<p>ON= Enabled OFF= Disabled</p>	

6.6. Functioning States

6.6.1. Off					
Timer	Controls		Combustion Fan	Auger	Igniter
	If Exhausting Temp. > Th01	→ goes in Extinguishing	OFF	OFF	OFF
	If room temp. > Th25	→ goes in Block			

6.6.2. Check Up					
Timer	Controls		Combustion Fan	Auger	Igniter
T01	If Exhausting Temp. > Th09	→ goes in Normal	Max Speed	OFF	OFF

6.6.3. Pre-Heating					
Timer	Controls		Combustion Fan	Auger	Igniter
T02	If Exhausting Temp. > Th09	→ goes in Normal	U01	OFF	ON

6.6.4. Pre-Loading					
Timer	Controls		Combustion Fan	Auger	Igniter
T03	If Exhausting Temp. > Th09	→ goes in Normal	U01	ON	ON

6.6.5. Fixed Phase					
Timer	Controls		Combustion Fan	Auger	Igniter
T04	If Exhausting Temp. > Th09	→ goes in Normal	U01	C01	ON

6.6.6. Variable Phase					
Timer	Controls		Combustion Fan	Auger	Igniter
T04	If Exhausting Temp. > Th09	→ goes in Normal	I-Ignition: U01 II-Ignition: U10	I-Ignition: C01 II-Ignition: C10	ON If Exhaust Temp. < Th02
	If Exhausting Temp. > Th06	→ goes in Stabilization			
Control after T05	If Exhausting Temp. < Th06	→ tries again Ignition			
		→ goes in Extinguishing phase with error Er12 in case of finished number of attempts			

6.6.7. Stabilization					
Timer	Controls		Combustion Fan	Auger	Igniter
T06	If Exhausting Temp. > Th09	→ goes in Normal	U02	C02	ON If Exhaust Temp. < Th02
		→ tries again Ignition			
	If Exhausting Temp. < Th06	→ goes in Extinguishing phase with error Er12 in case of finished number of attempts			
Control	If	→ goes in Normal			

after T06	Exhausting Temp > Th06 +d01				
-----------	------------------------------------	--	--	--	--

6.6.8. Recover Ignition

The system goes in Recover Ignition:

- After a lack Voltage Supply when the stove were in **ON**, when the voltage return if the Exhausting Temperature > **Th06+D01**
- Pushing the button **ON/OFF** when the system is in **Extinguishing**

Timer	Controls		Combustion Fan	Auger	Igniter
T16	If Exhausting Temp. > Th01 Thermostat	→ waits and continues extinguishing	U09	OFF	OFF
Control after T16	If Exhausting Temp. < Th01 Thermostat	→ starts Timer T16 of final cleaning	Max Speed		
	If Exhausting Temp. < Th01 Thermostat	→ goes in Check Up			

6.6.9. Normal

Parameter	Controls		Combustion Fan	Auger	Igniter
T14	If Exhausting Temp. < Th03 Thermostat or If Exhausting Temp.< Extinguishing Thermostat for the used power	→ starts Timer T14 of pre-extinguishing waiting	User's Power	User's Power	OFF
Control after T14					

	Er03				
	If Exhausting Temp. > Th07				
	Thermostat				
	If room temp.>				
	Thermostat				
A01=1	If Room Temperature >	→ goes in Modulation			
	Room Thermostat				
A07=1	If Input AUX open				
A01=2	If Room Temperature >	→ goes in Standby			
	Room Thermostat				
A07=2	If Input AUX open				
T15 Control after T15	If Exhausting Temp > Th08	→ starts Timer T15			
	Thermostat				
	If room temp.>				
	Th25				
	Thermostat				
	→ Goes in Extinguishing phase for Security				

6.6.10. Modulation

Parameter	Controls		Combustion Fan	Auger		Igniter	
T14 Control after T14	If Exhausting Temp. < Th03	→ starts Timer T14 of pre-extinguishing waiting	A06=1	A	A	A	
	Thermostat or			06	06	06	
	If Exhausting Temp. < Extinguishing Thermostat for the used power		=0	=1	=0		
	→ Goes in Extinguishing with error Er03		U11	U03	C11	C03	OFF

6.6.11. Standby

Parameter	Controls		Combustion Fan	Auger	Igniter
T13 Extinguishing Control after T13	If Exhausting Temp. > Th28 Thermostat	→ starts Timer T13	U09	OFF	OFF
	If Exhausting Temp. > Th28 Thermostat	→ wait			
T16 Final Cleaning	If Exhausting Temp.< Th28 Thermostat	→ starts T16	Max Speed		
Control after T16	→ Goes in Standby OFF		OFF		

6.6.12. Extinguishing

Parameter	Controls		Combustion Fan	Auger	Igniter
T13 Extinguishing Control after T13	If Exhausting Temp.> Th01 Thermostat	→ starts Timer T13	U09	OFF	OFF
	If Exhausting Temp. > Th01 Thermostat	→ Wait			
T16 Final Cleaning	If Exhausting Temp.< Th01 Thermostat	→ starts Timer T16	Max Speed		
Control after T16	→ Goes in OFF without errors		OFF		
	→ Goes in Block with possible errors				

6.6.13. Block

Controls	Combustion Fan	Auger	Igniter
To exit: Push for 3 seconds button P1 With no more block conditions → Goes in OFF	OFF	OFF	OFF

6.7. Functions

6.7.1. Modem management

The system manages a modem module (given on demand) for the dialogue with the stove through SMS to operate the Ignition, Extinguishing, State's request and have information about the Block/Alarms conditions. The Modem is connected to the Control Board's port RS232 with cables and connectors given; it is supplied with a AC/DC Power Supply unit.

- Use a SIM card in the Modem enabled to the traffic GSM data. Disable the PIN request from the SIM
- The Modem management is activated with the parameter A50 =1
- The insertion and removal of the SIM card **MUST** be done with the Modem **NOT** supplied.

The user can send an SMS to the Modem's SIM with a command word written both capital and small letters.

Start	To start Ignition from stove OFF. The Modem sends back a message to the number from which it received the command with a status and a possible alarm error code.
Stop	To start Extinguishing from stove ON. The Modem sends back a message to the number from which it received the command with a status and a possible alarm error code.
Status	To ask the stove's State . The Modem sends back a message to the number from which it received the command with a status and a possible alarm error code.
Learn	To Learn the number to send an SMS in case of Block. If there is a Block condition, the Modem automatically sends a message to the learnt number with the stove's state and the alarm

	error code.
--	-------------

6.7.2. Supply Voltage Lack Management

In case of Supply Voltage lack, the system saves the most important functioning data. With the return of the Supply Voltage, the system evaluates the saved data and:

- If the stove were ON and the Exhausting Temperature more than **Th06+d01** the system goes in **Recover Ignition**.

Pushing the button P1 it is possible the sudden new system's Ignition.

- If the stove were ON but the Exhausting Temperature is less than **Th06+d01** the system goes in Extinguishing with error **Er15**.
- If the stove were OFF, or in Extinguishing or Block, the system returns in the previous state.
- In case of prolonged absence of Supply Voltage (about one week) the systems goes in BLOCK with error message **Er11** to indicate not correct DAY and TIME value.

After the reset by the button P1, the **Time** value blinks signalling the need to set the right Time.

6.7.3. Combustion power change delay Management

When the system exits from the Ignition and goes in Normal, the Combustion Power, starting from the Combustion.

Power 1, reaches the target one increasing the value with the delay time as the timer **T18**.

The other manual or automatic power changes are managed and actuated with the delay time as timer **T17**.

6.7.4. Brazier's periodic cleaning

When the stove is activated, the system automatically starts the brazier's periodic clearing.

With intervals as Timer **T07** (minutes) the Combustion is taken to Periodic Cleaning Power according to parameters **C08** and **U08** for the Timer **T08** (seconds).

6.7.5. Automatic combustion power management

In the Combustion Power setting, the user can set the Automatic modality [A]

The work power is automatically selected according to the Room Temperature and the value of the selected Boiler Thermostat:

- Room temperature \leq **Boiler Thermostat-d08**
→The system goes to the maximum available Combustion Power
- **Boiler Thermostat-d08** < Room Temperature < **Boiler Thermostat**.
→The Combustion Power decreases reaching the Boiler Temperature.
- Room Temperature \geq **Boiler Thermostat**
→The system goes to Combustion Power 1 if **A06=0** or to Modulation Power if **A06=1**.

Example:	A06 = 1	Modality = [A]	Boiler Thermostat =26 °C	d08 = 5 °C	P03 = 5
-----------------	----------------	-----------------------	---------------------------------	-------------------	----------------

Room Temperature °C	≤ 21	22	23	24	25	≥ 26
Work Combustion Power	Power 5	Power 4	Power 3	Power 2	Power 1	Power 1

6.7.6. Pellet Load Correction Management

The user could correct the Auger's times ON of Pellet Loading in Step $-7 \div 7$

P15 is the percentage value of the single correction Step and is applied on the Work default values.

C03=2,0	C03=2,0	C03=2,0	C03=2,0	C03=2,0	C03=2,0	C03=2,0	C03=2,0
C03=1,8	C03=1,8	C03=1,8	C03=1,8	C03=1,8	C03=1,8	C03=1,8	C03=1,8

The defined values are within the defined range **P27 \div P05**.

6.7.7. Combustion fan correction management

The user could correct the Combustion Fan Speed in Step $-7 \div 7$

P16 is the percentage value of the single changing Step and is applied on the Work default value.

U03=1000	U03=1000	U03=1000	U04=1200	U05=1400	U06=1600	U07=1800	U11=900
U03=1150	U03=1150	U03=1150	U04=1380	U05=1610	U06=1840	U07=2070	U11=1035

The defined values are within the defined range **P14 \div P30**.

6.7.8. Speed combustion fan management.

The parameter **P25** sets the regulation modality of the Exhausting Fan Speed.

P25=0	Exhausting Fan without Encoder: the speed is defined by the set voltage value [Volt]. The Regulation Step is of 5 Volt.
P25=1	Exhausting Fan with Encoder: the speed is defined by the set number of turns [RPM] In case of signal presence but regulation failed, the system goes in BLOCK with Er08 alarm.
P25=2	Exhausting Fan with Encoder: the speed is defined by the set number of turns [RPM] In case of signal presence but regulation failed, the system goes in BLOCK with Er08 alarm. In case of sensor break with absence of the signal, the system goes in BLOCK with Er07 alarm. After the reset of the BLOCK done by the button P1, the system goes Automatically to P25=0

7. Cleaning and maintenance

It's mandatory to clean regularly the pellet stove and the exhaust system. This ensures efficient stove operation.

IMPORTANT! Do not use any acid-contain detergents or flammable substances when cleaning the pellet stove and the exhaust system. May cause fire!

7.1. Cleaning and maintenance of exhaust gas tube

TAR is liquid formed during poor combustion and low temperature in exhaust gas tube. If exhaust gas tube is layered with tar, insulate well the outside of exhaust tube. Tar deposition may cause fire. It's mandatory at least once per heating season

inspection and cleaning of exhaust gas system.

ATTENTION! Inspect and clean exhaust gas system (chimney) before the first start of pellet stove!

7.2. Cleaning and maintenance of the pellet stove

Cleaning and maintenance of the pellet stove must be performed regularly.

Clean the stove outer surface, glass, rope on the door, ash container periodically.

Clean the pellet burner daily.

Clean the pellet hopper once per month.

It's mandatory to clean stove totally for burned pellet amount of 800 kg to 1000 kg or once per year.

ATTENTION! FOLLOW THESE STEPS WHEN CLEANING:

- Switch OFF the pellet stove.
- Wait until the pellet stove cools completely.
- Switch OFF the power supply.
- Do not use flammable detergents.

When making routine check the authorized service must do as following:

- Cleaning the fan;
- Cleaning all the inaccessible places burner;
- Complete check of the ignition system and the pellet loading system;
- Complete check of the condition of the insulations ropes on the door and to change it if needed;
- Dismounting and cleaning the T-connection of the exhaust gases system;
- Complete check of all the electrical parameters;
- Issuing an inspection report for the actions performed.

Cleaning the outer surface of pellet stove

Use soft cloth and neutral cleaning detergents.

Cleaning the door glass

Door glass is self-cleaned during stove operation. However, the glass may dim from inside after a few hours of operation. The main reason is the quality of used pellets and operation of exhaust gas system.

To clean the door glass OFF-and-cool the stove.

Use soft cloth with small quantity glass cleaning detergent.

After each cleaning check for distance of 2mm (two) between glass and upper edge

of the door (see the image).

Check /change of the door insulation rope

Rope ensures door tightness and proper operation of pellet stove.

Check the insulation rope periodically. If any damage is found, please contact an authorized service to replace the insulation rope with a new one.

The rope is not covered by warranty.

Removing the ash from the pellet stove

Check the ash container at bottom part of pellet stove. Turn off the stove, wait until gets cool and then clean it. It's mandatory to clean the ash container daily. Dispose the ashes in a non-combustible container with a lid.

Cleaning of the burner



Use a vacuum cleaner to clean the burner from ash once per day. Cleaned burner ensures proper stove operation.

In case of lot of dust and sawdust into the pellet hopper during stove operation, immediately stop operation of stove and clean the pellet hopper and burner properly. Refuel pellet hopper again. If pellet hopper still has of lot of dust and sawdust, replace the used pellets with quality ones!

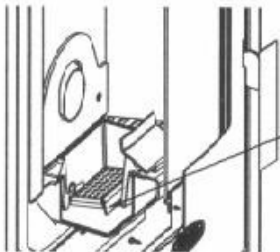

When burner apertures are filled with impurities, open and clean the burner.

Cleaning of pellet hopper

It is recommended the periodic hopper cleaning (at least once per month).

The cleaning must be done as following: first, empty the pellet hopper; second, use a vacuum cleaner to clean the hopper.

Cleaning of silicone hose of pressure switch

At least once a year.



1- Use inspection opening underneath the burner to remove the ash of exhaust pipes.

After cleaning, close the system.

When using of low quality pellets, it's recommend that cleaning be done once a month.

Inspection and cleaning of fresh air system

It's mandatory to inspect the fresh air system at the beginning of each heating season. Any malfunctioning must be repaired.

Inspection and cleaning of exhaust gas system

It's mandatory to inspect the exhaust gas system at the beginning of each heating season. If the electric cable is damaged should be replaced with a new one.

8. Aftersales service

When bought a pellet stove you must contact an authorized installer/service for installation and start. The authorized installer/service fills in the warranty card and the service manual of the product.

9. Warranty terms

The warranty terms are described in the Service booklet included in the supply.

10. Recycling and waste disposal

Submit all packaging material for recycling according to the local regulations and requirements.

At the end of life cycle of each product its components are due to be disposed of in conformity with regulatory prescriptions. Obsolete equipment shall be collected

separately from other recyclable waste containing materials with adverse effect on health and environment.

According to Directive 2002/96/EC regarding electrical and electronic equipment waste, disposal thereof is required separately from the normal flow of solid household waste.

Expired appliances must be collected separately from other recyclable waste containing substances hazardous to health and environment. Both metal and nonmetal parts are sold out to licensed organizations for recyclable metal or non-metal waste collection. In any case they should not be treated as household waste.

